

Xem Dưới
Đây

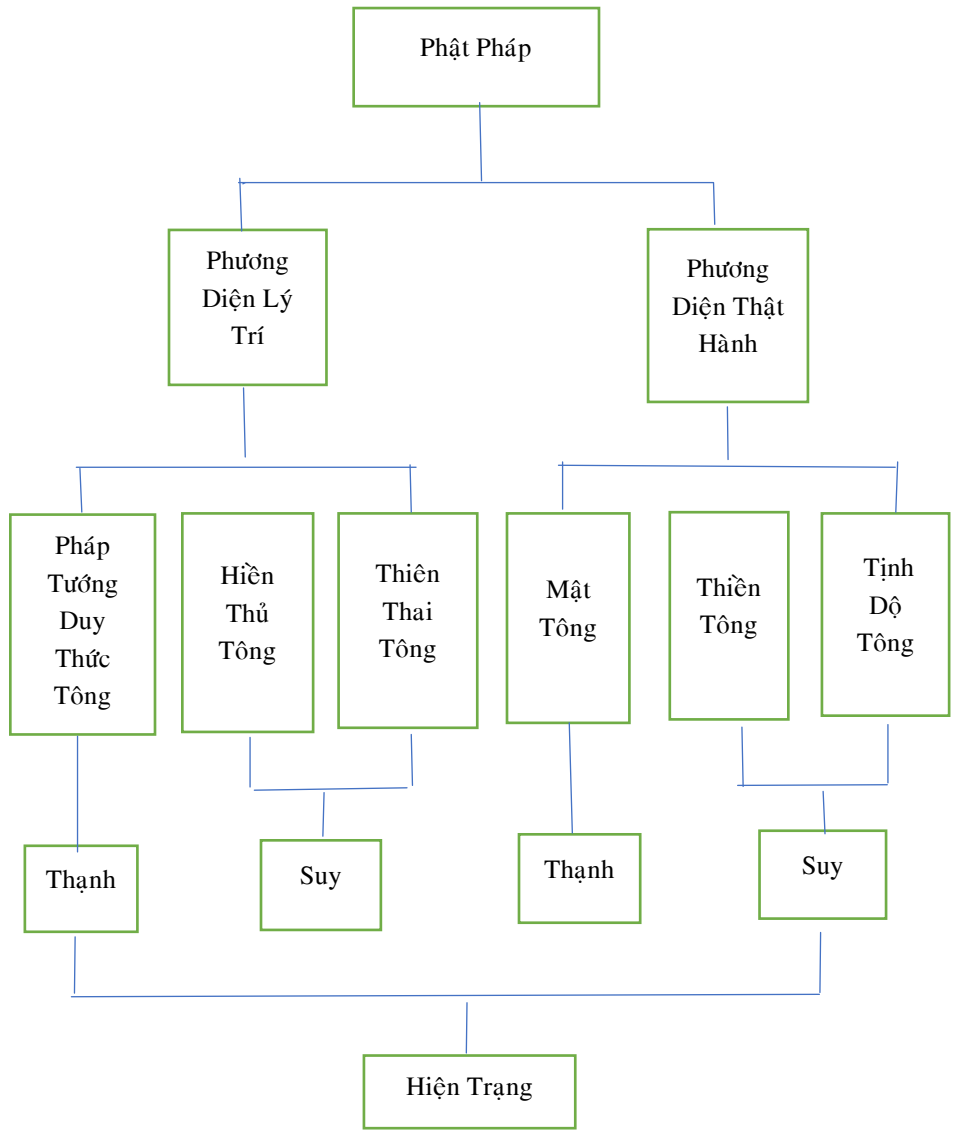

Xin Xem Sơ Đồ Dưới
Đây

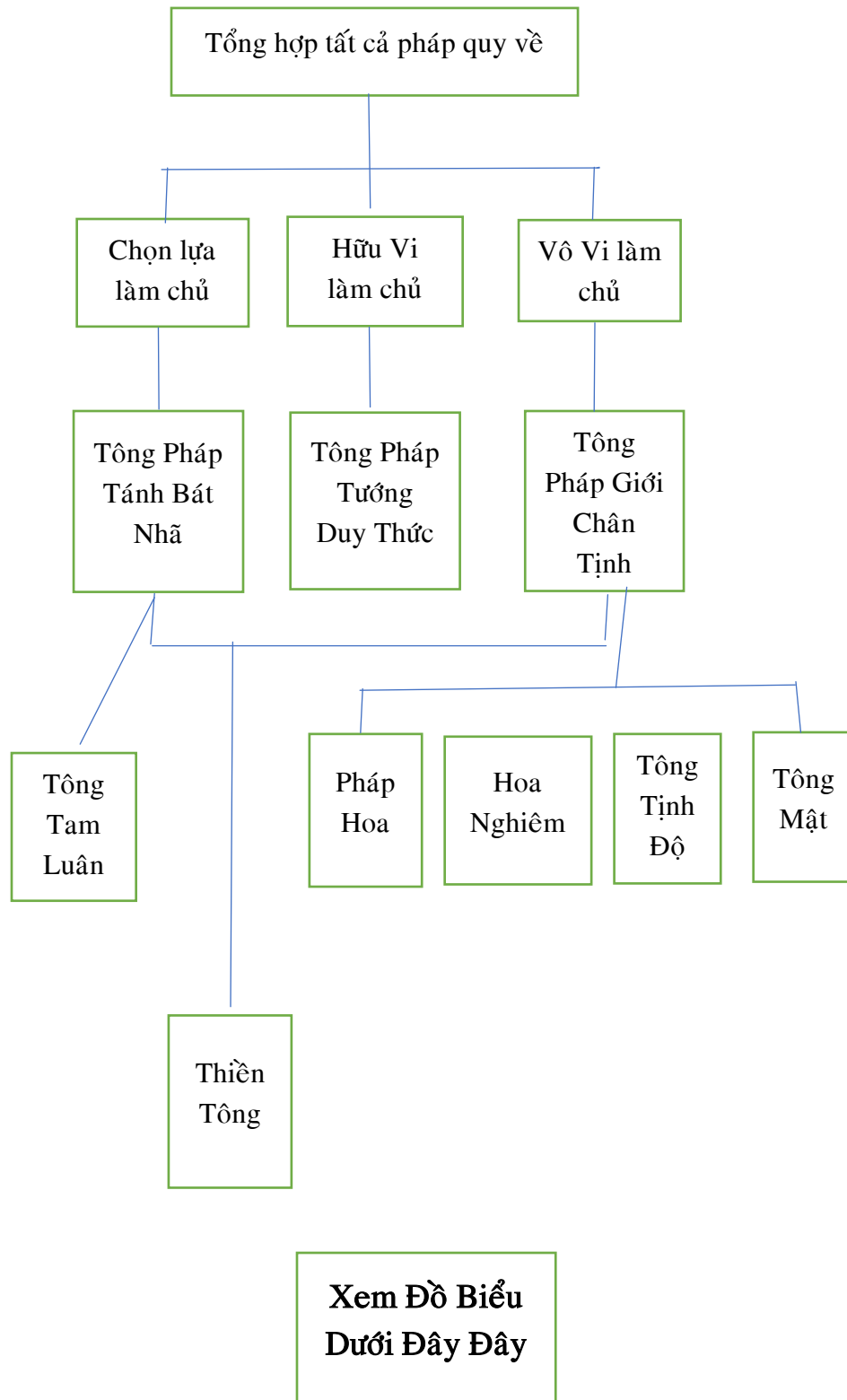

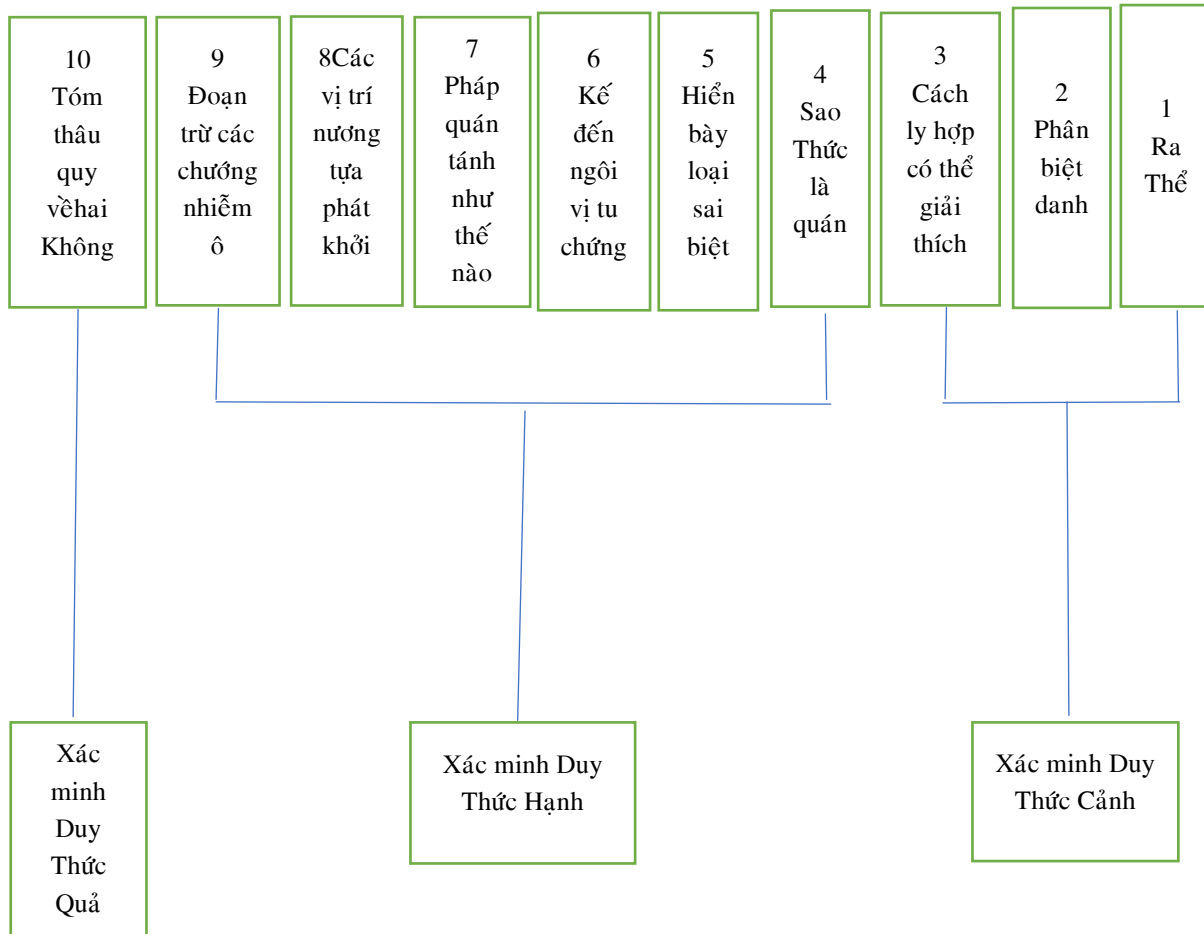

Đồ biểu dưới đây

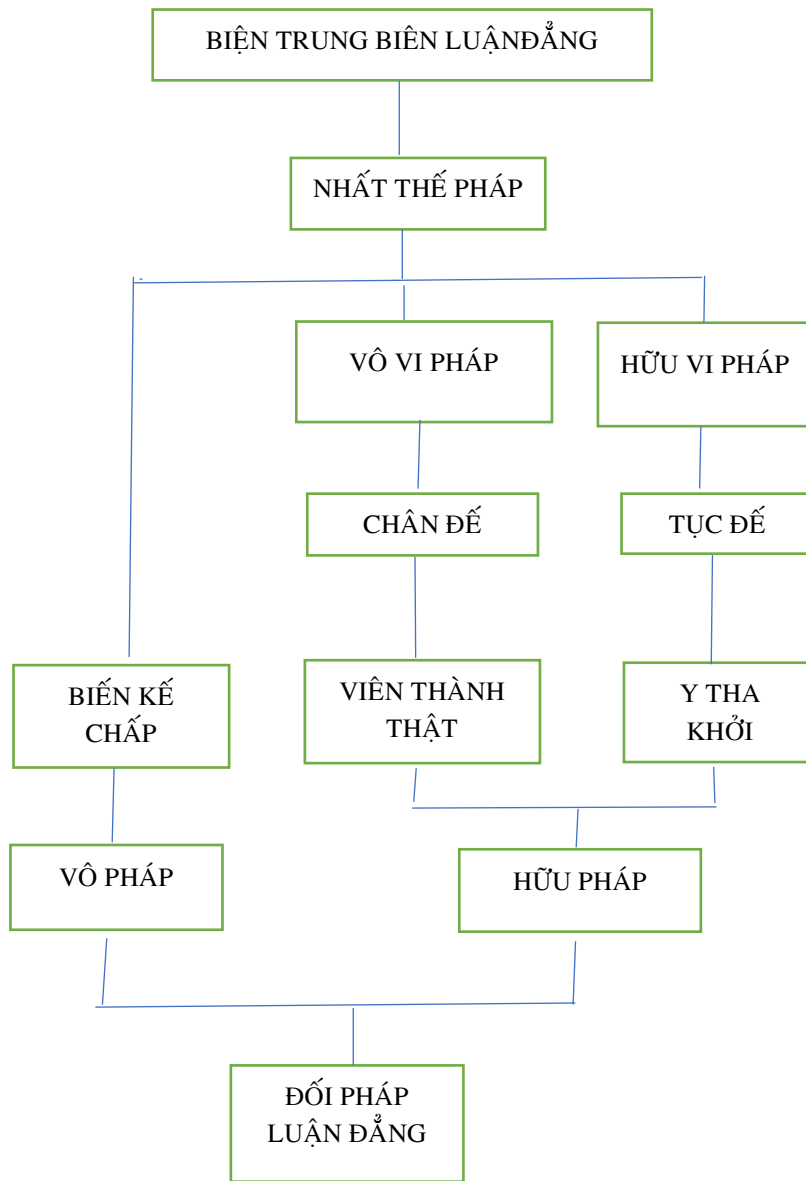

VẠN HỮU

LỤC ĐẠI
DUYÊN
SANH

NGÃ

NGŨ UẨN
GIẢ GIẢ

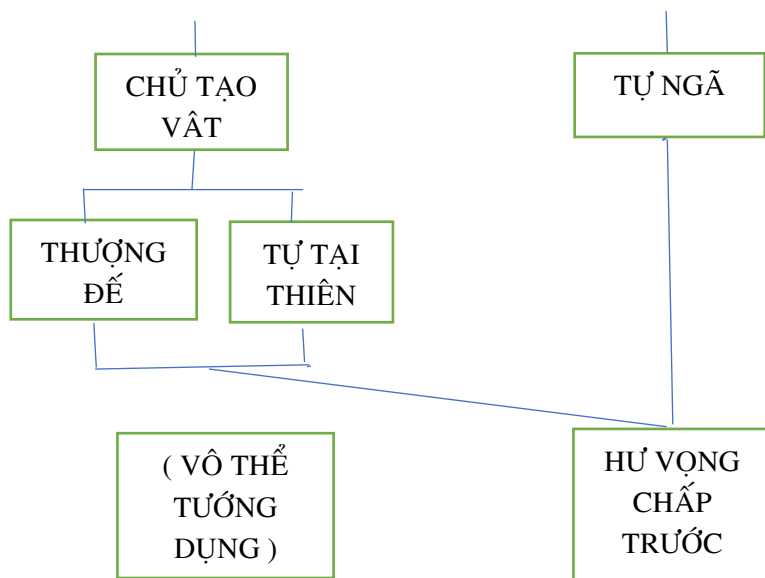

XEM SƠ ĐỒ
DƯỚI ĐÂY

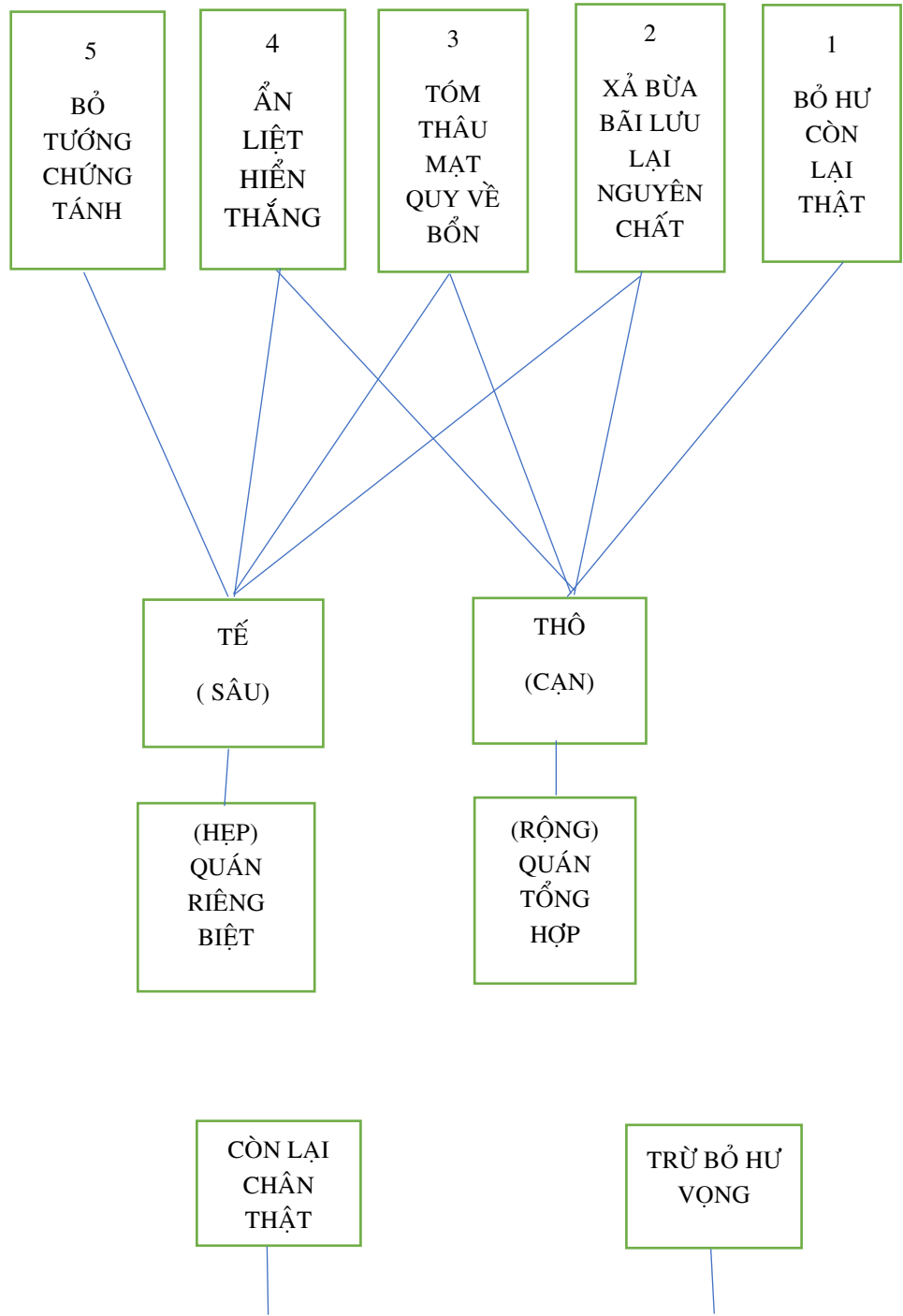

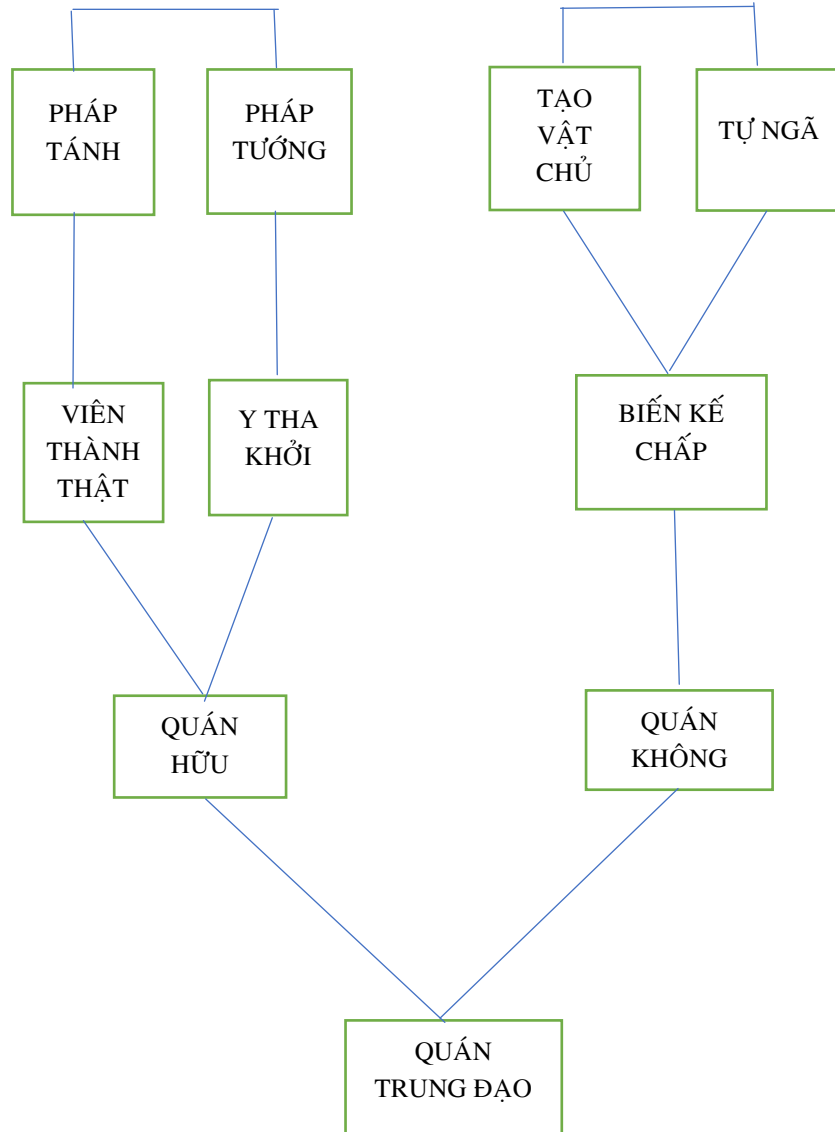

XEM ĐỒ BIỂU
DƯỚI ĐÂY

QUÁN TỬ TẦM TỬ

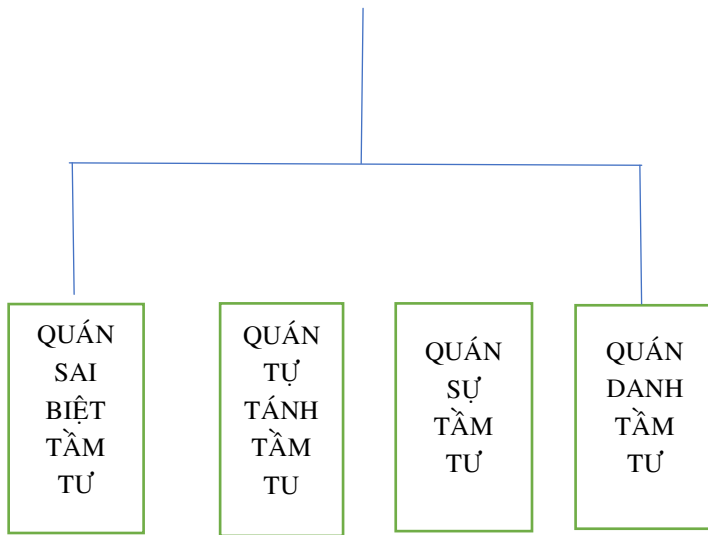

XEM ĐỒ BIỂU DƯỚI ĐÂY

TỬ TRÍ NHƯ THẬT

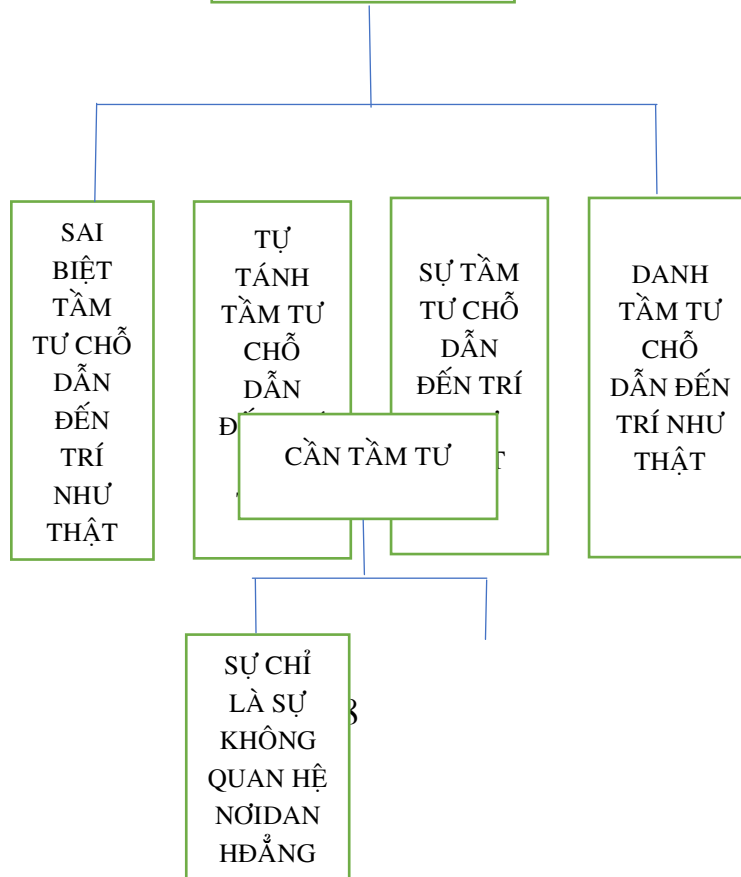

DANH CHỈ
LÀ DANH
KHÔNG
QUAN HỆ
NƠI SỰ
ĐẲNG

TÁM THỨC, NĂNG BIẾN,
DUY LƯỢNG

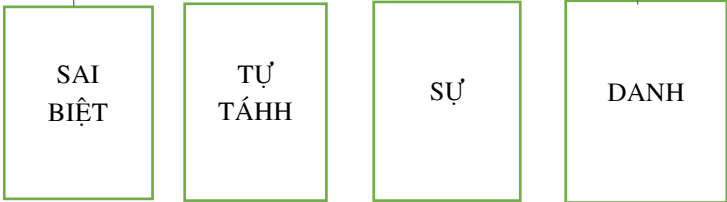

DUY GIẢ,
TƯỚNG
PHẦN, SỞ
BIẾN

SỰ BA
PHÂN BIỆT

TÊN BỐN
PHÂN BIỆT



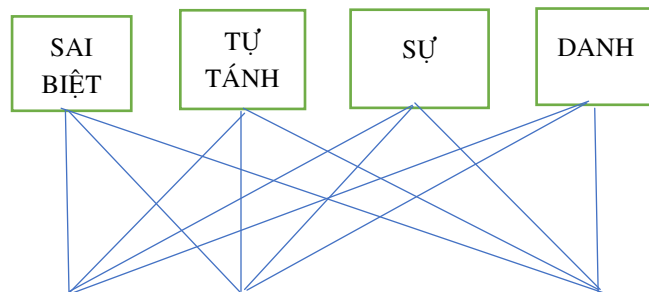
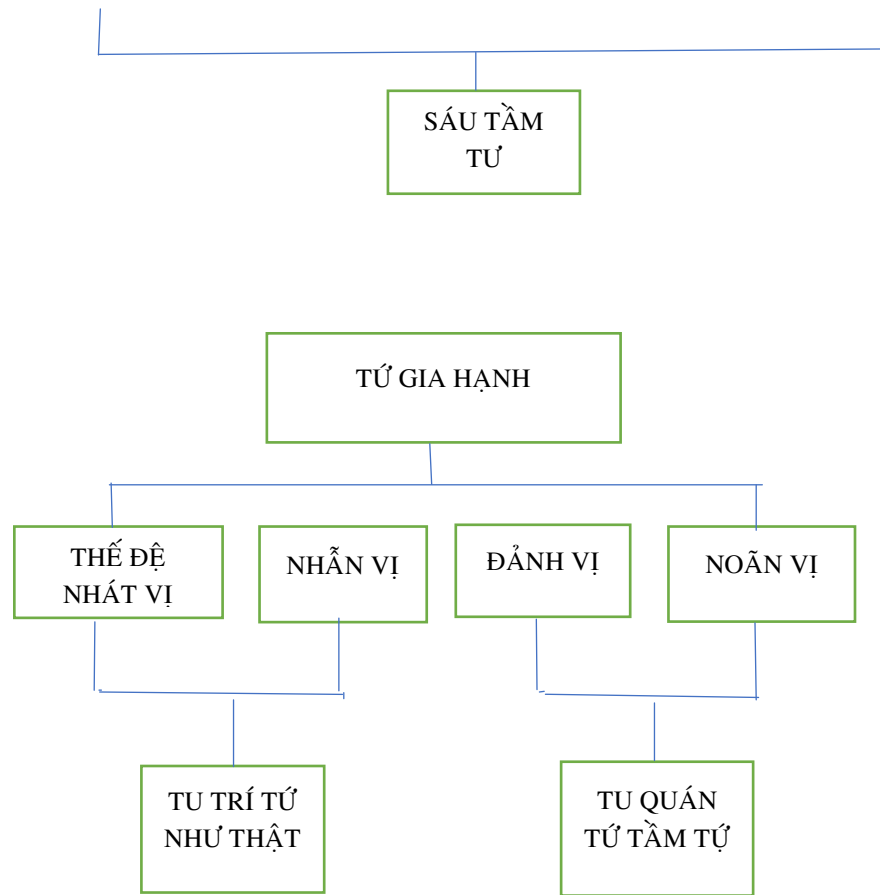

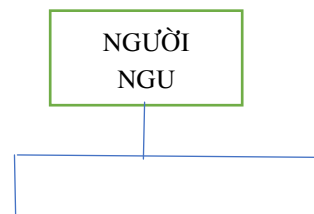
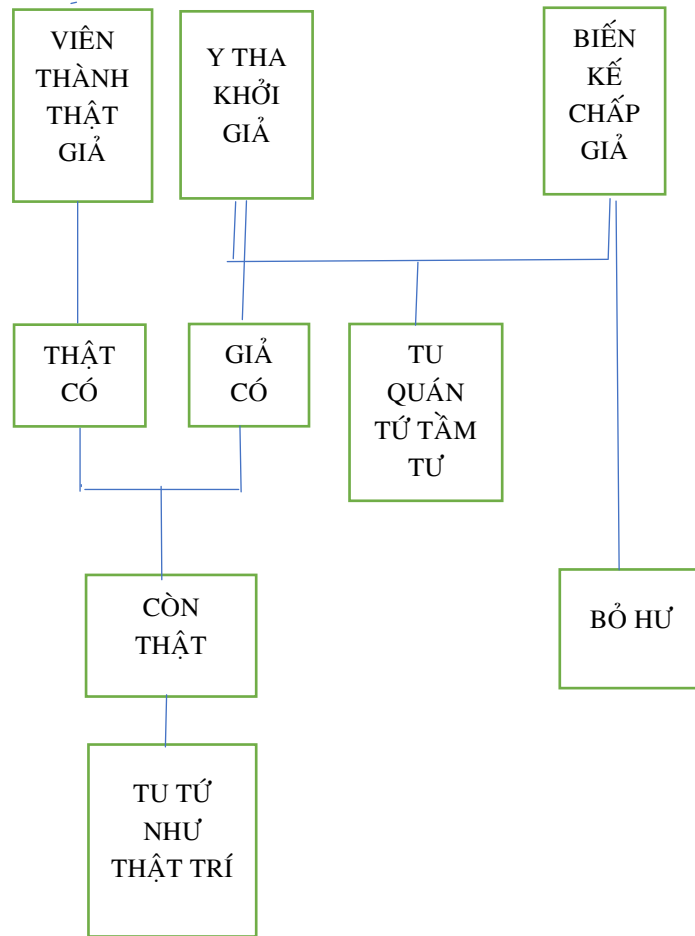

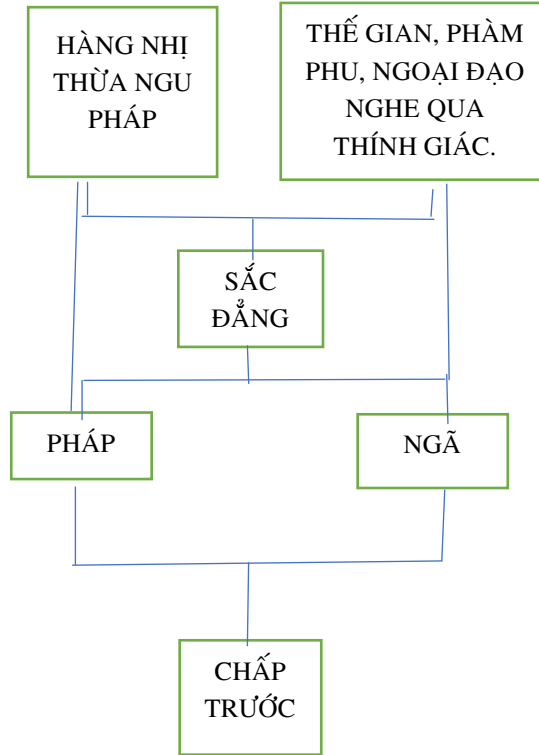

XEM ĐỒ HÌNH
DƯỚI ĐÂY

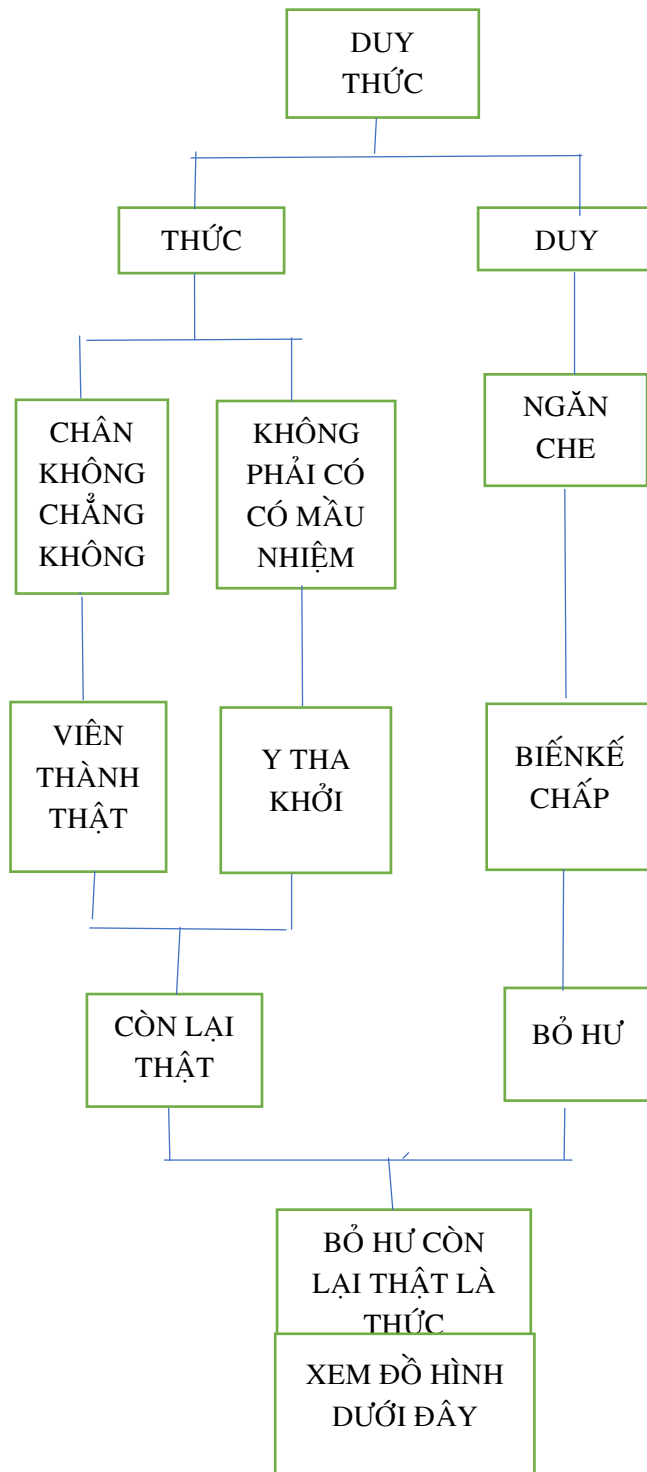

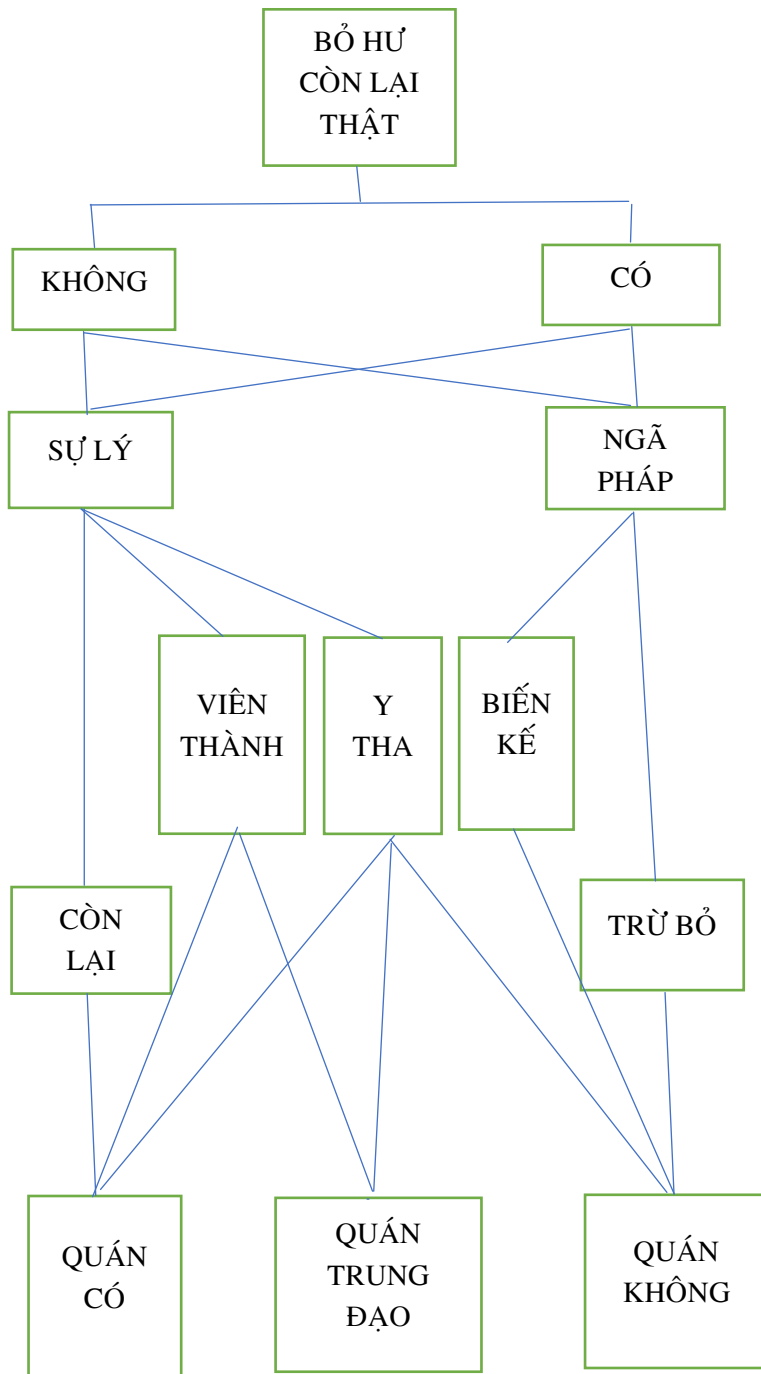

XEM ĐỒ
HÌNH
DƯỚI ĐÂY

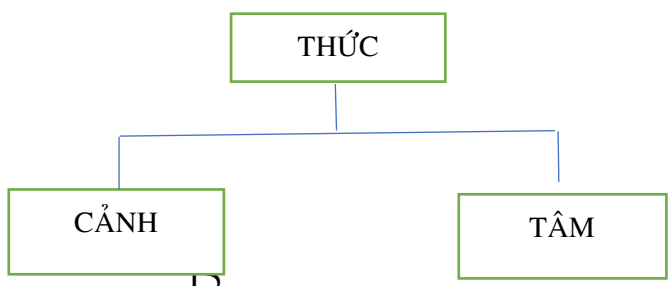
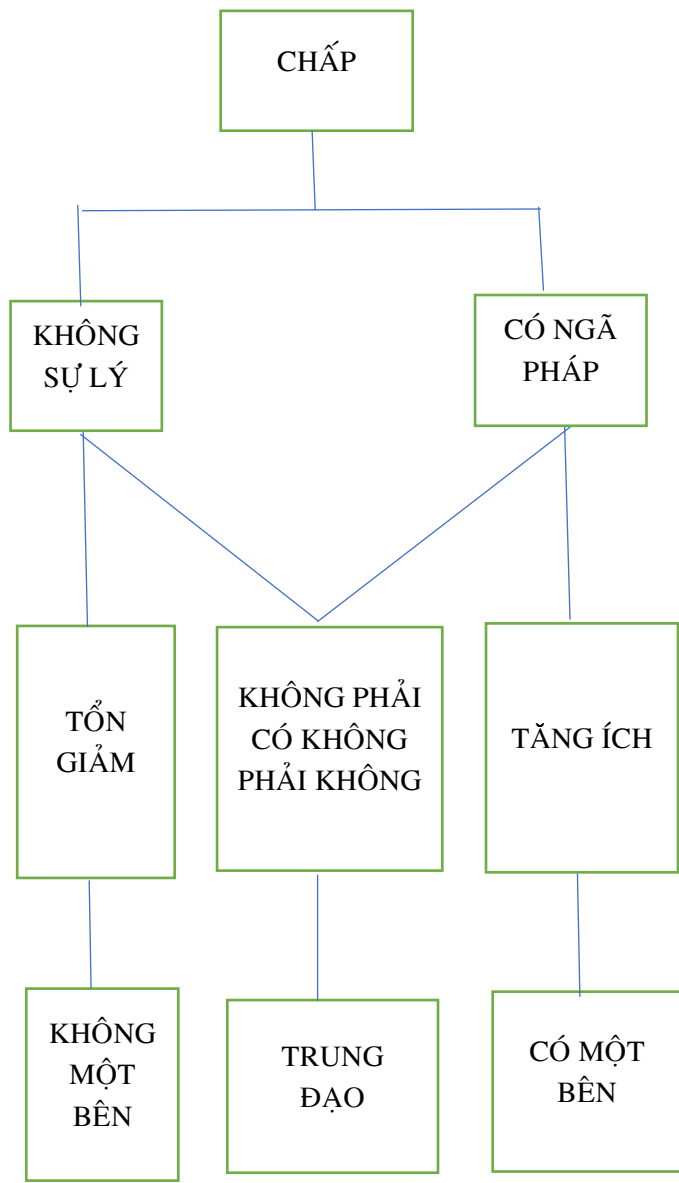

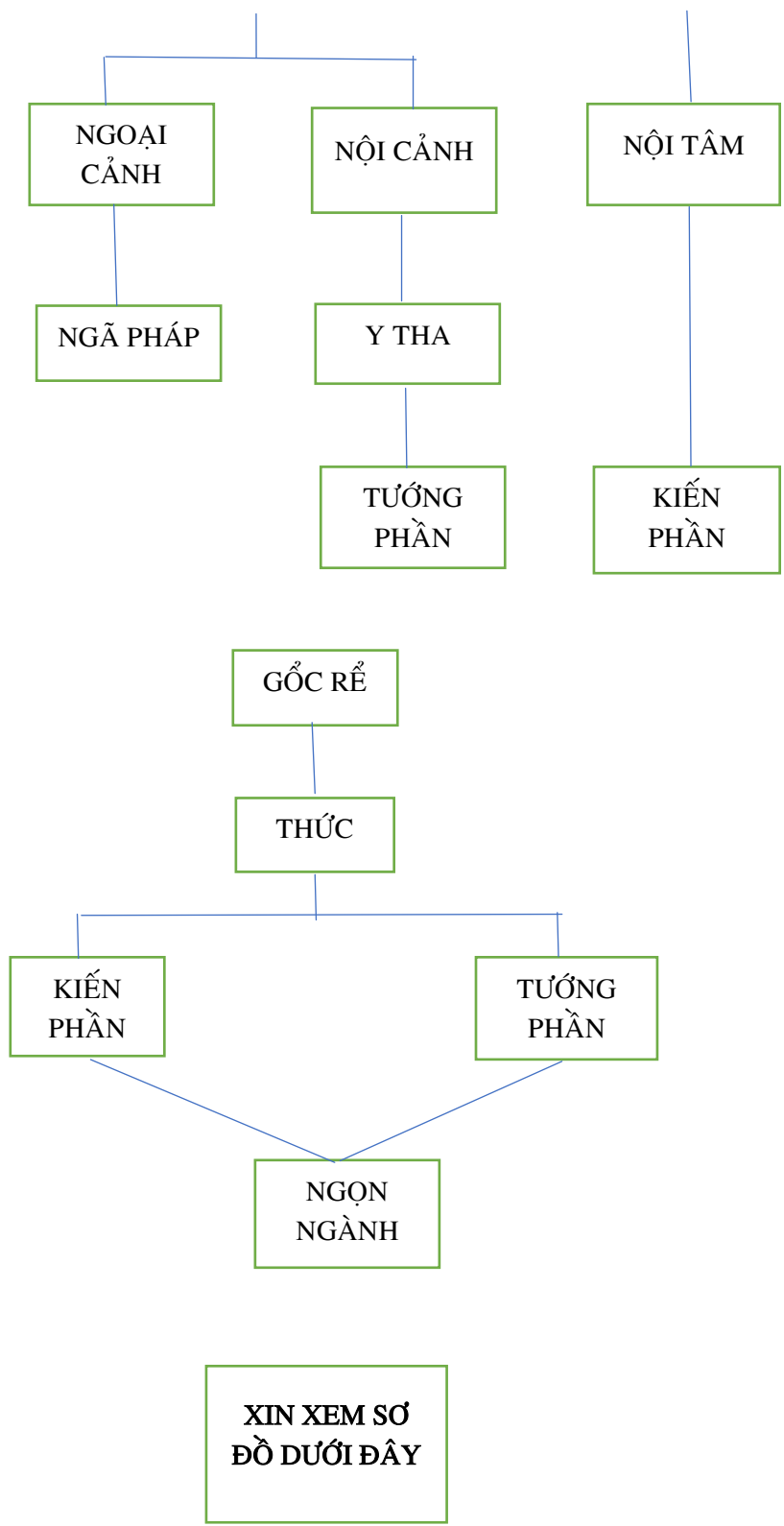

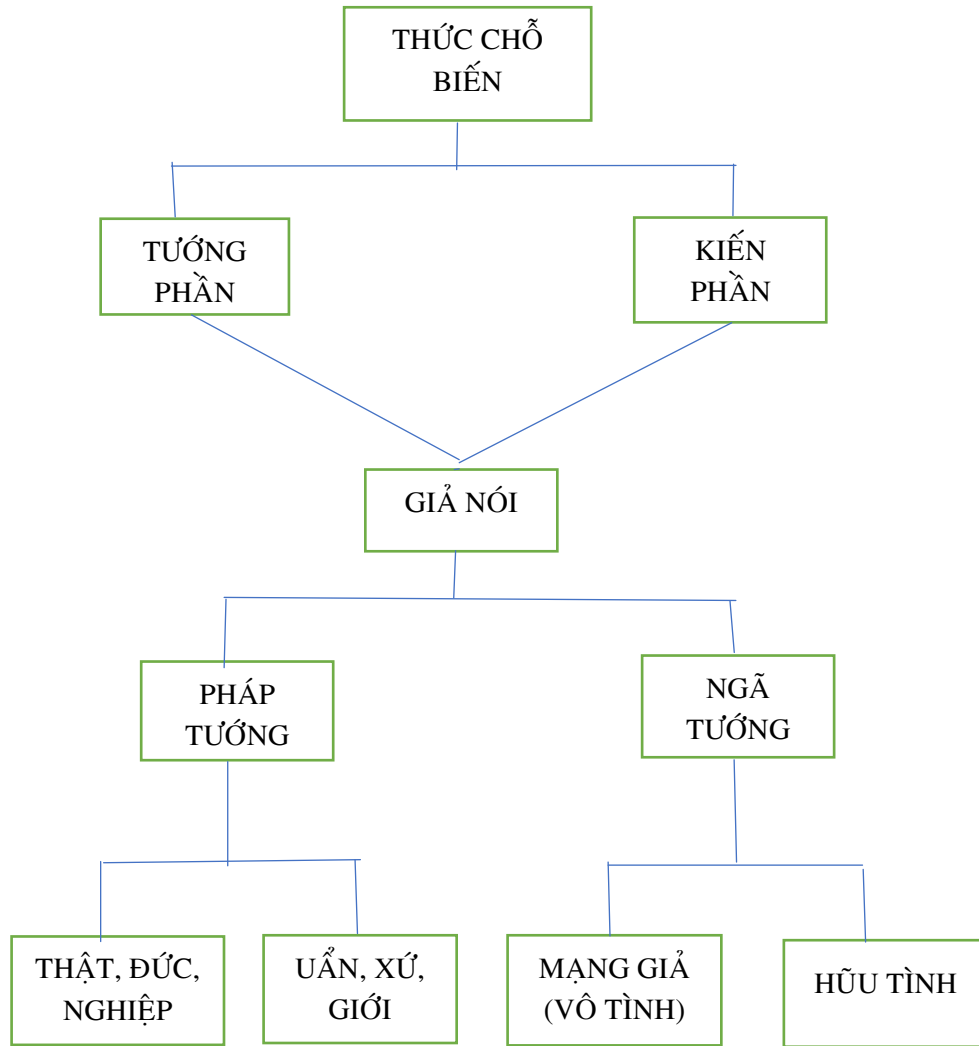

XEM ĐỒ
BIỂU DƯỚI
ĐÂY:

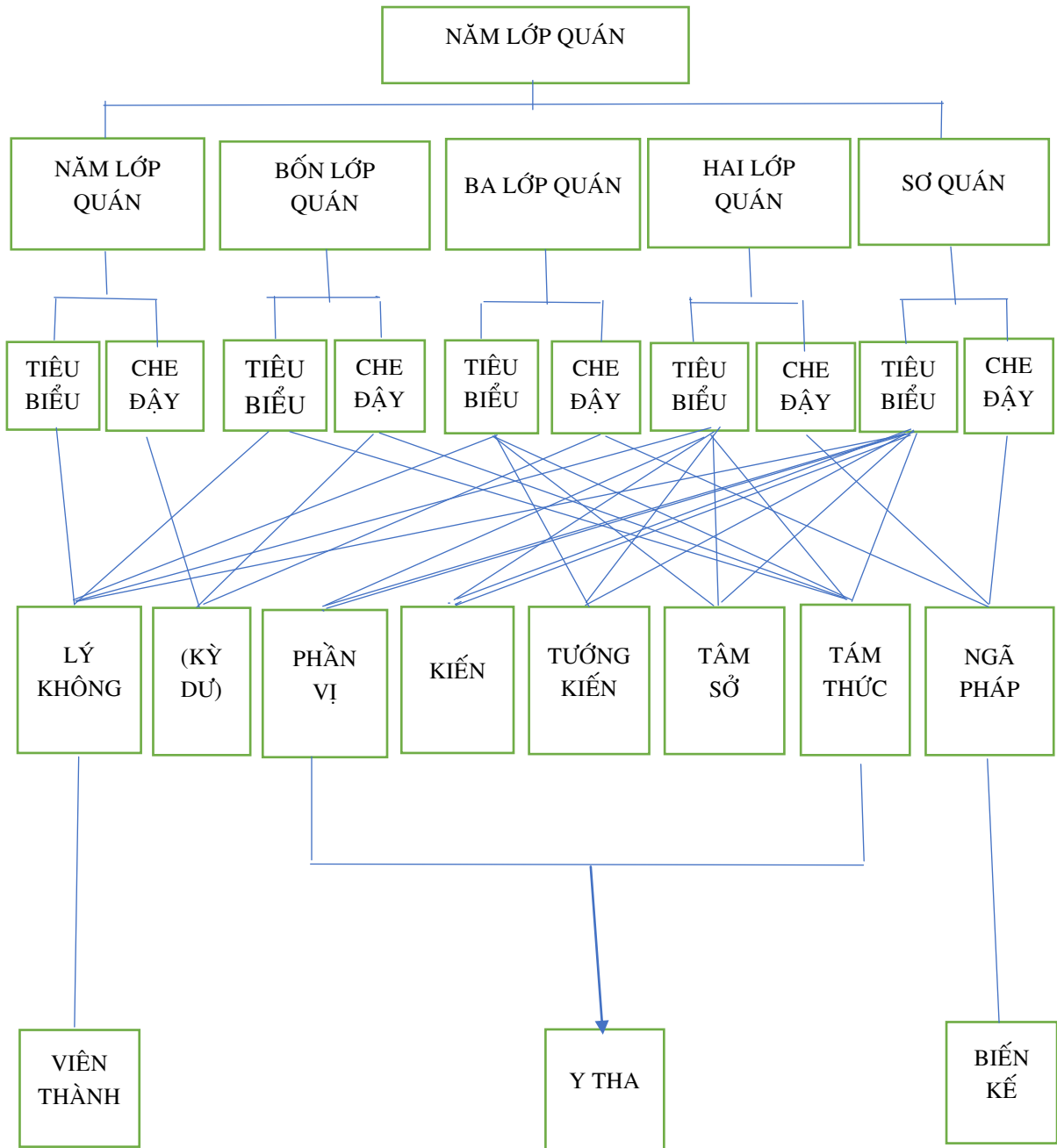

TỨ NHƯ
THẬT TRÍ

TỨ TÂM
TỨ QUÁN

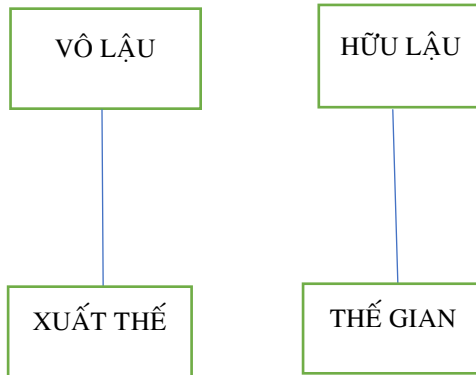

XEM ĐỒ
BIỂU DƯỚI
ĐÂY

TỬ GIA
HẠNH



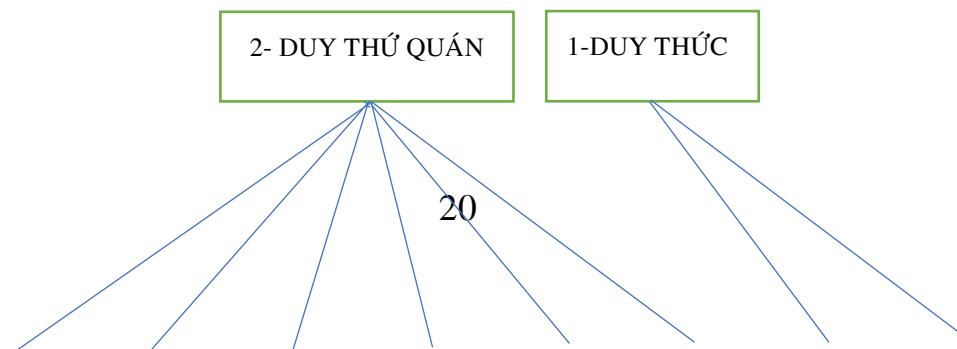
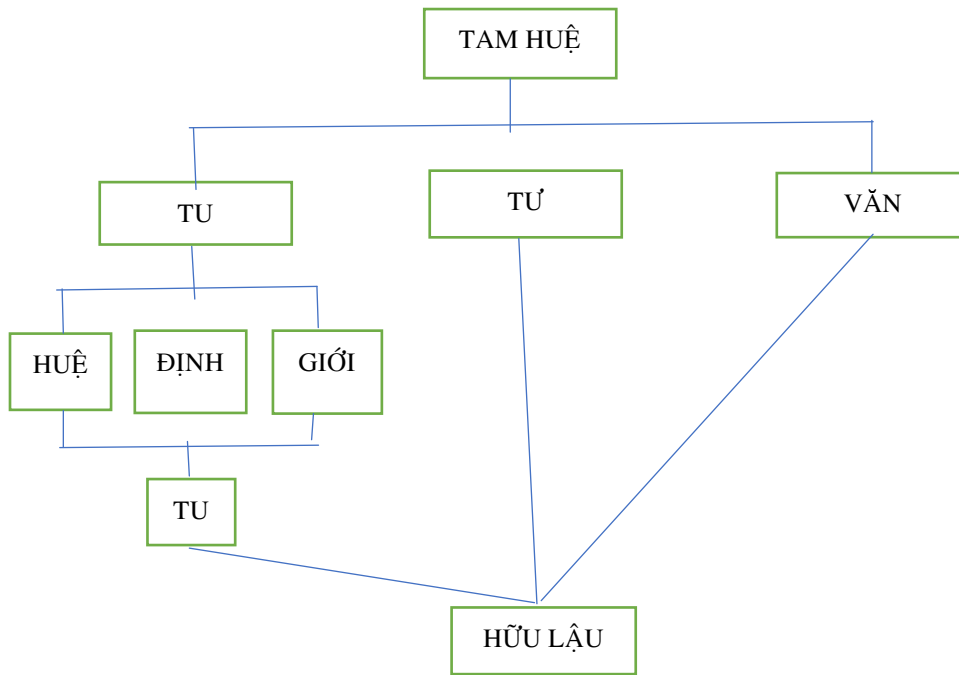
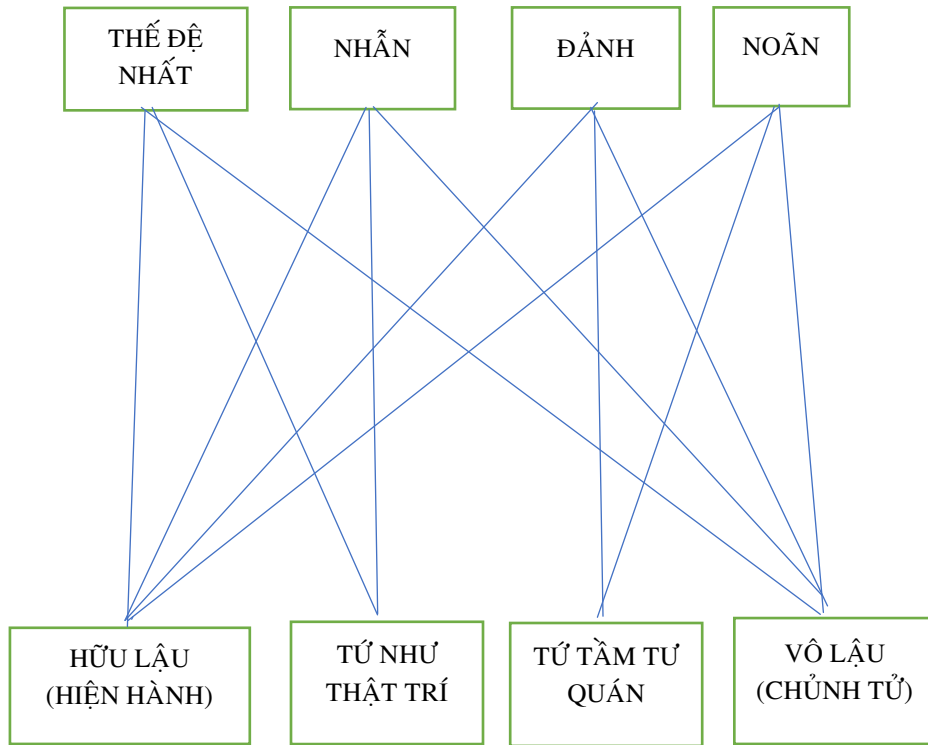

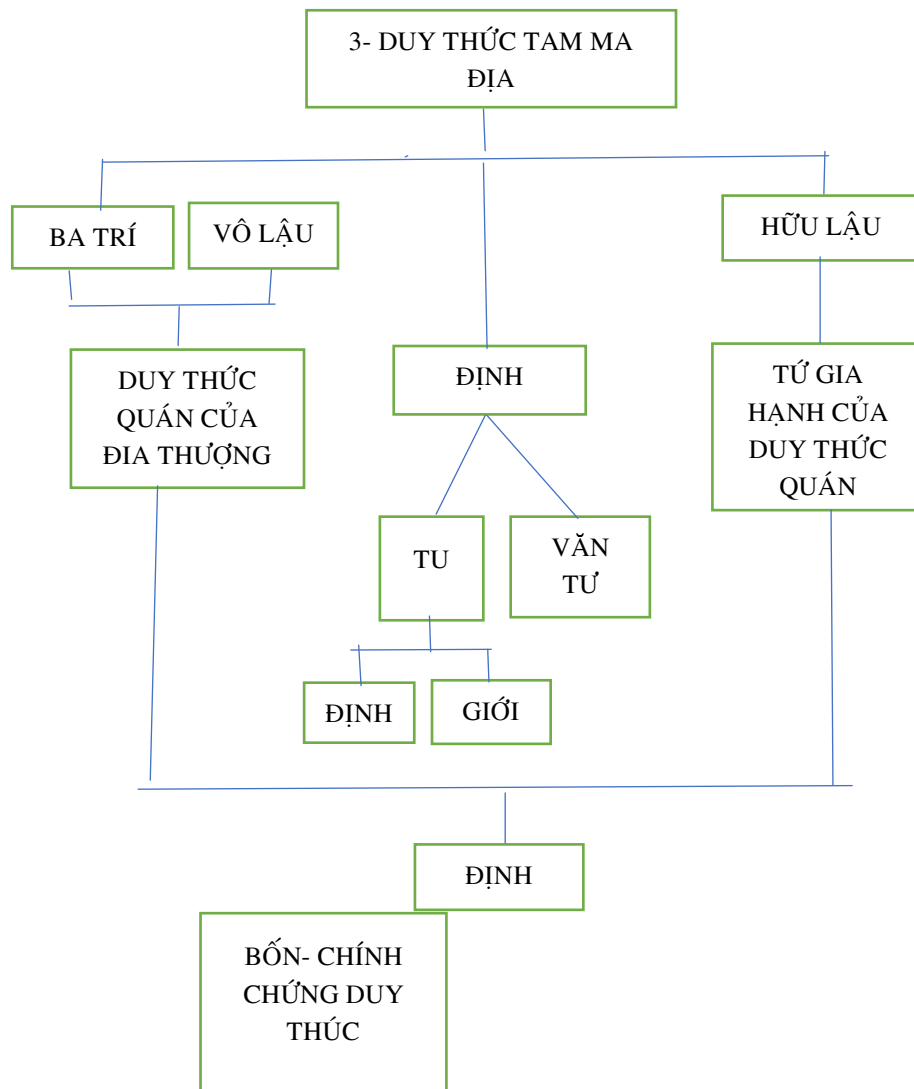

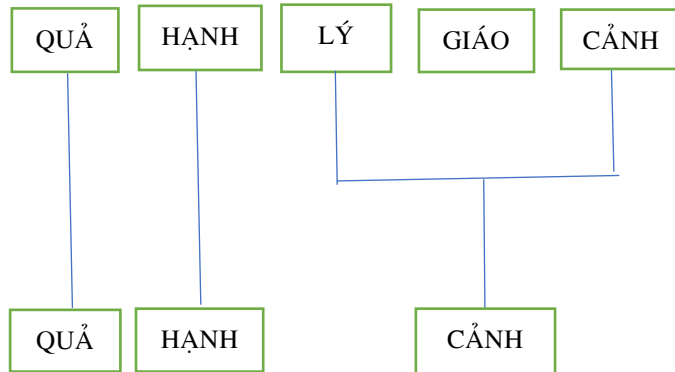
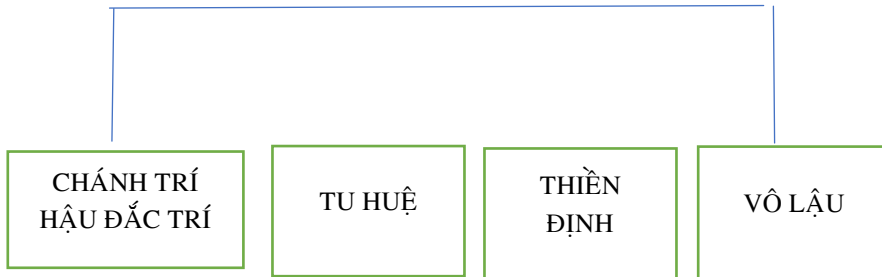

Y

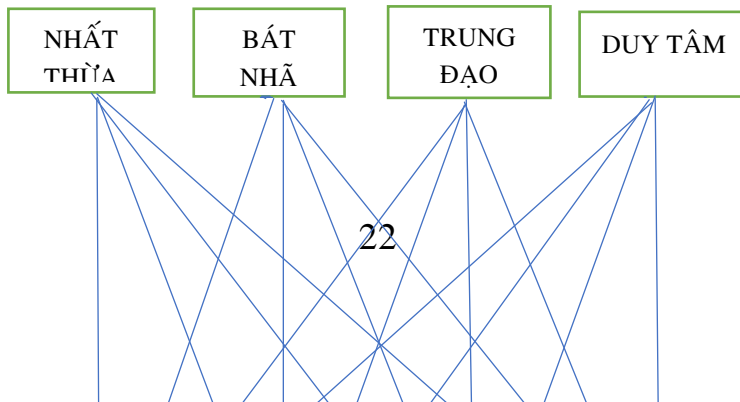

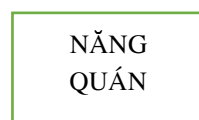

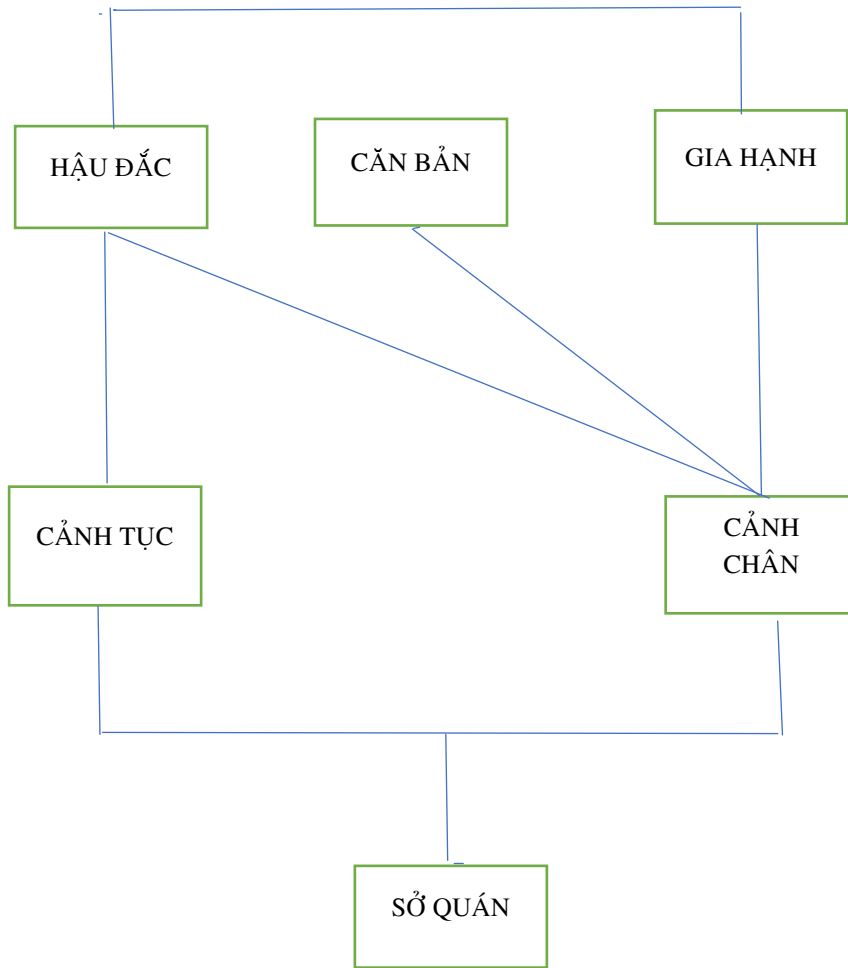

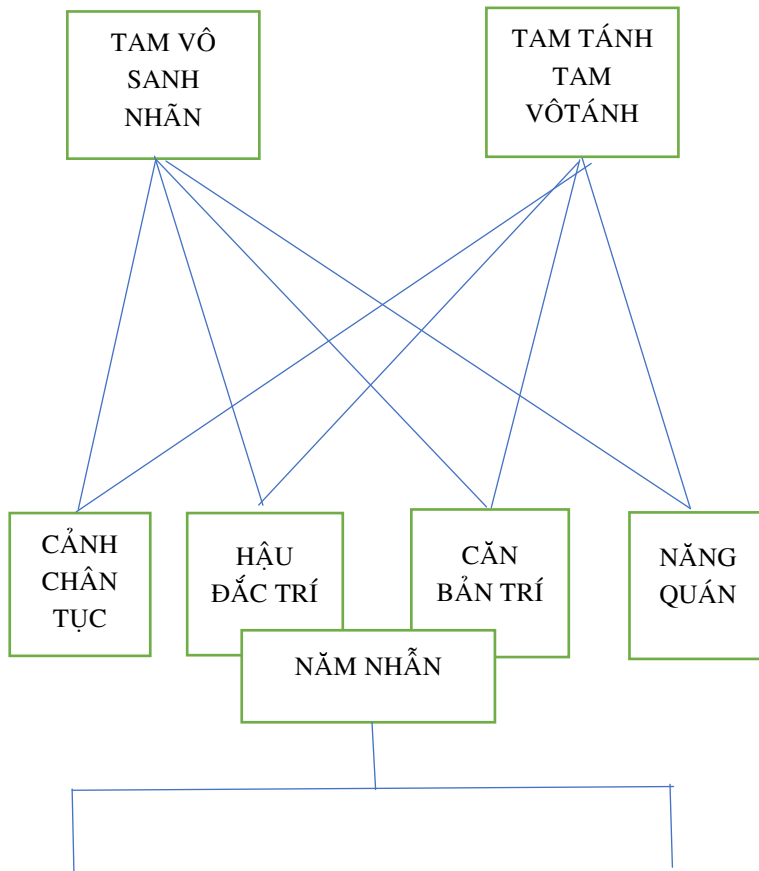

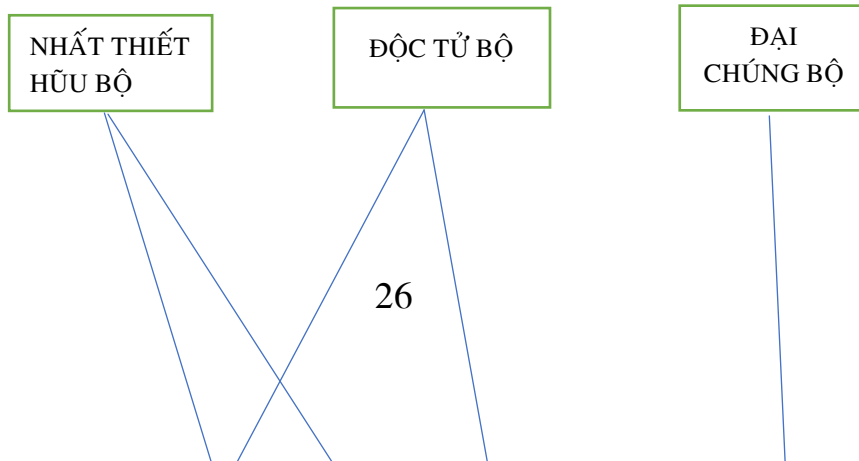
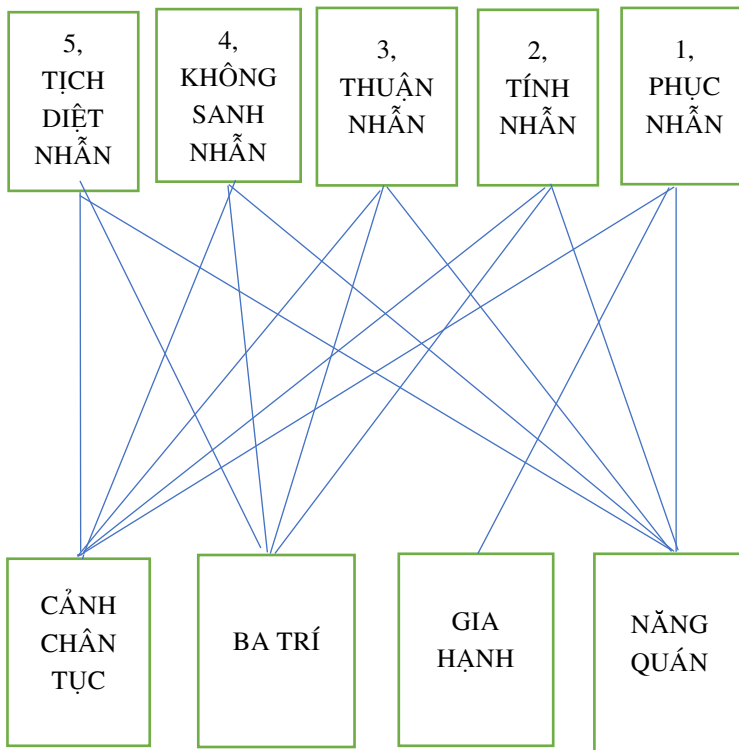

CHỈ THỨC
THỨ SÁU
TẬP NHIỆM

SÁU THỨC
ĐẦY ĐỦ
TẬP NHIỆM

THỨC THỨ
SÁU LÀM
NĂNG QUÁN

SÁU THỨC
LÀM NĂNG
QUÁN

XEM BỜ
BIỂU DƯỚI
ĐÂY

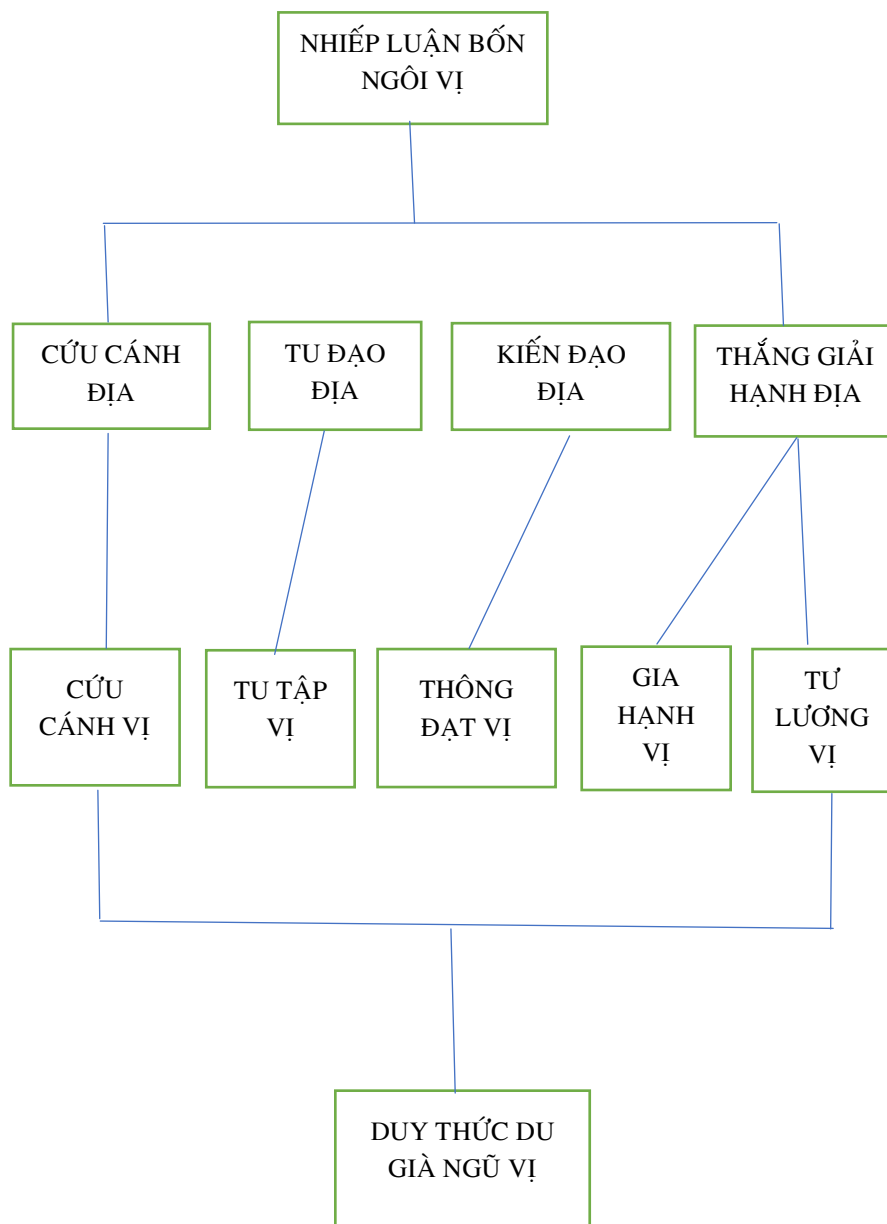

XEM ĐỒ BIỂU
DƯỚI ĐÂY

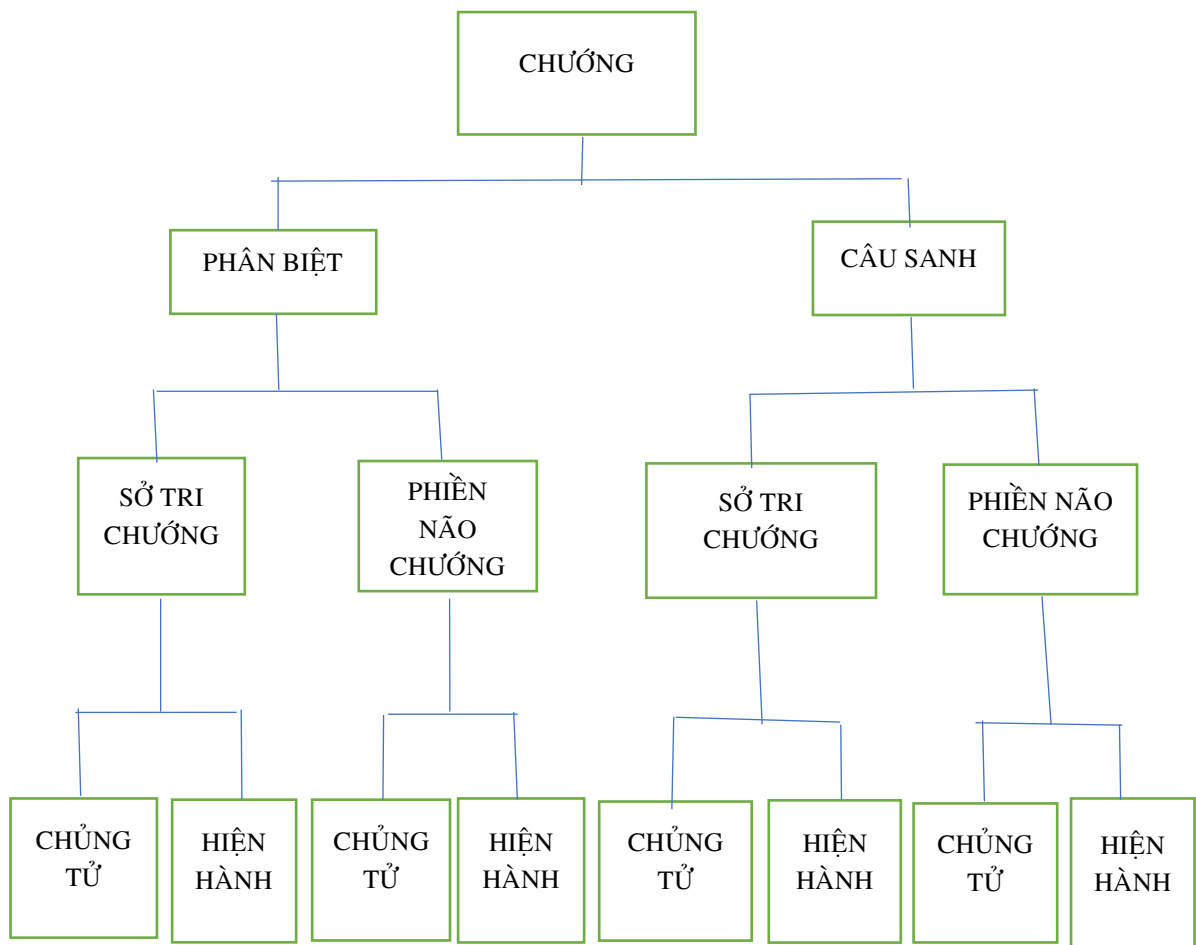

XEM ĐỒ BIỂU
DƯỚI ĐÂY

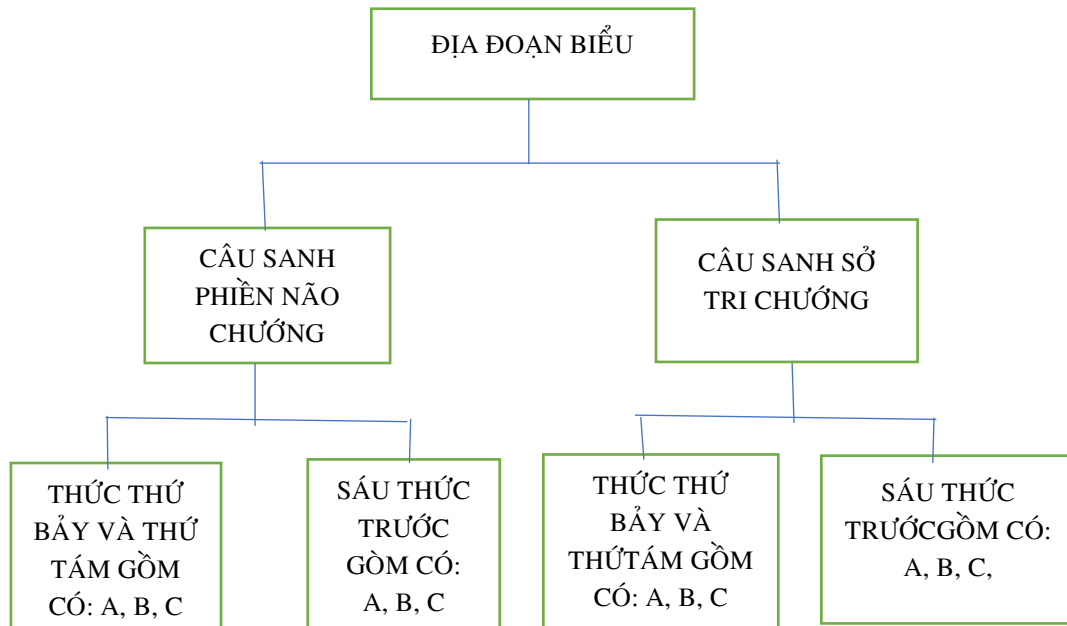

XEM HÌNH VẼ
DƯỚI ĐÂY

SÁU
PHIÊN
NÃO

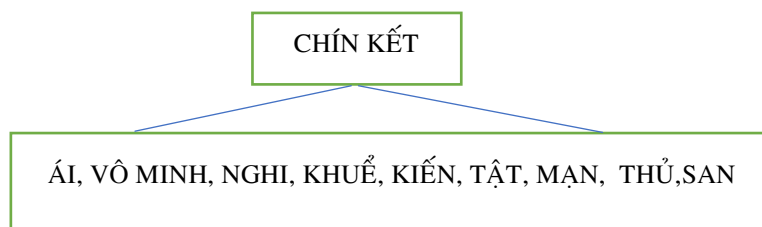
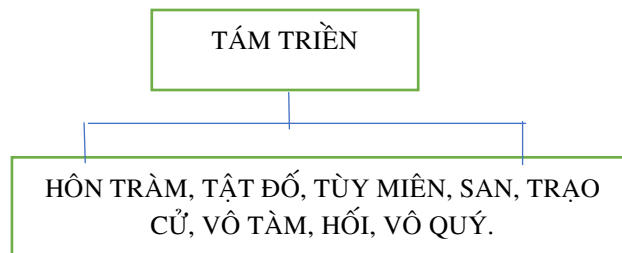
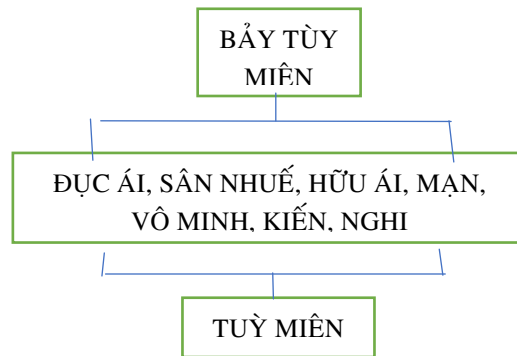
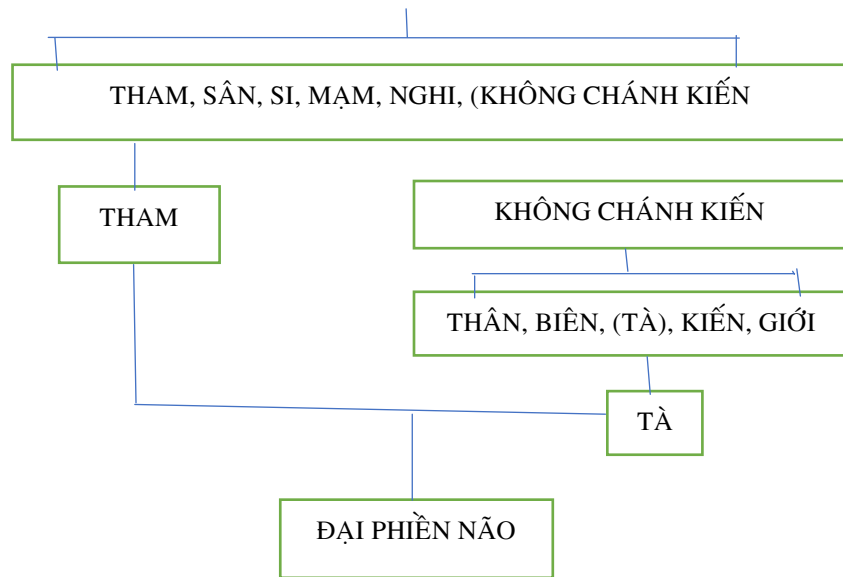

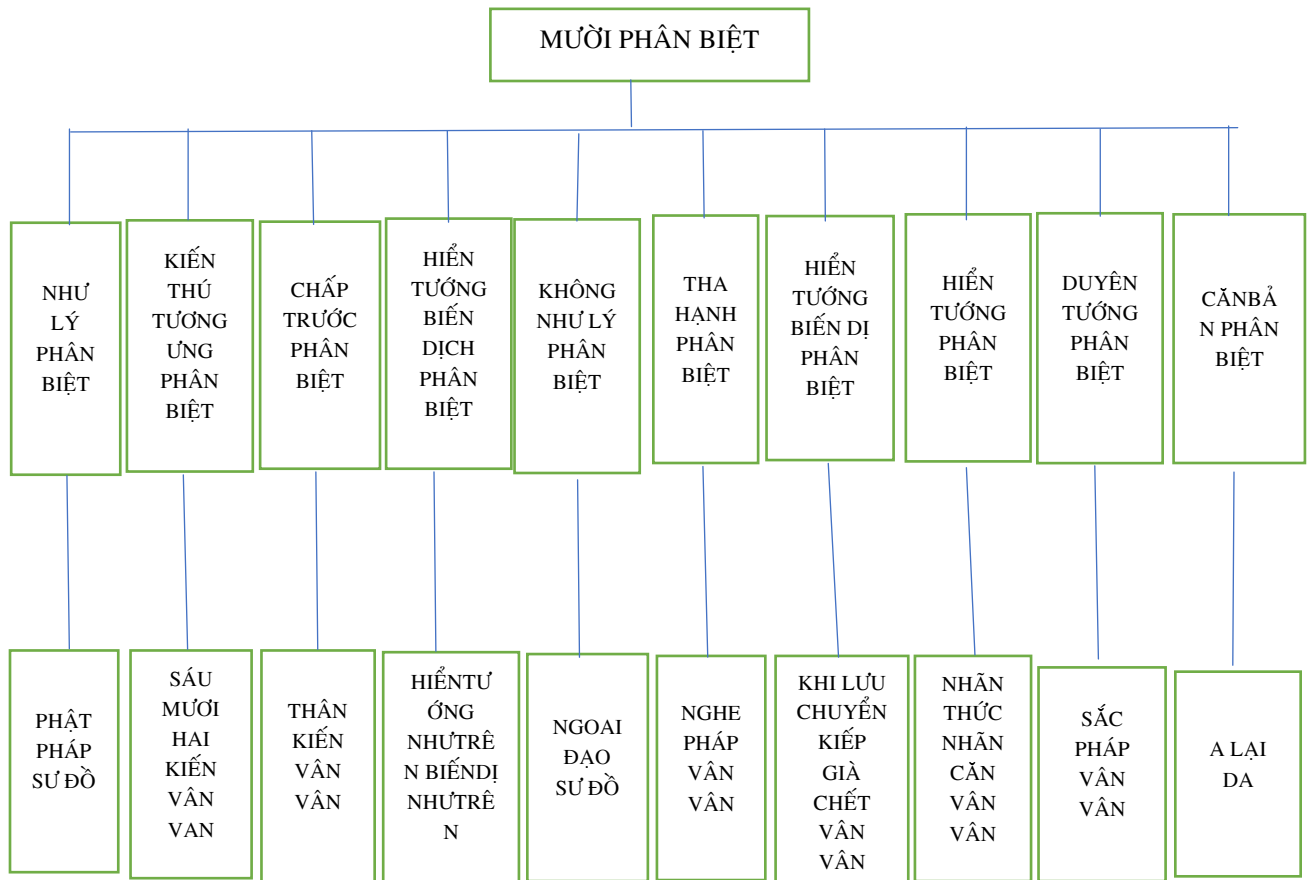

XEM ĐỒ BIỂU
DƯỚI ĐÂY

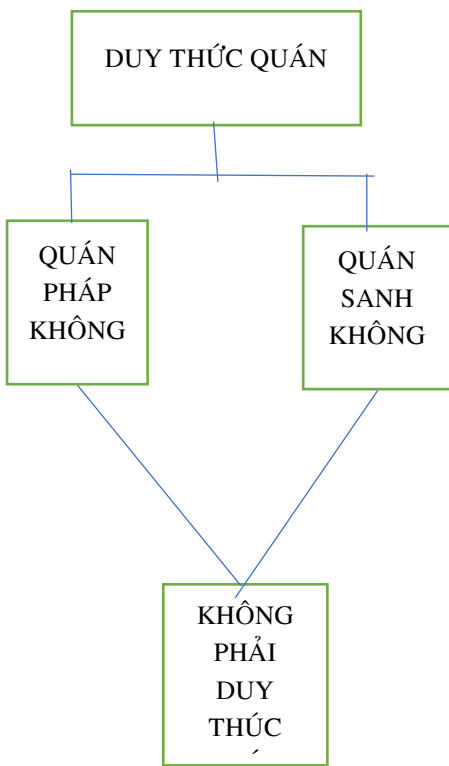

Dịch xong ngày 10. 5. 2022
Thích Thắng Hoan
Chùa Bảo Phước
Trung Tâm Phiên Dịch và Trước Tác